

# **KitchenAid®**

*Electric 27" and 24" Built-In  
Single and Double Self-Cleaning Ovens*

**Models KEBI271W and KEBI171W  
KEBI241W and KEBI141W**

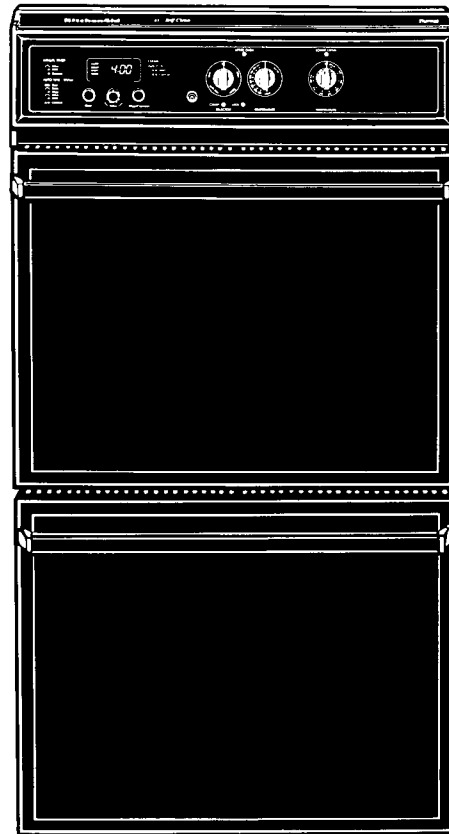

**USE and CARE GUIDE**

# Table of Contents

	Page
Important Safety Instructions .....	3-4
You Are Responsible For .....	4
Ownership Registration .....	5
Built-In Oven Features .....	6-7
Using The Oven .....	8-18
Electronic Clock Operation .....	8
Single/Upper Oven Controls .....	9
Lower Oven Control .....	9
Preheating The Oven .....	9
Baking In The Oven .....	10
Roasting In The Oven .....	14
Automatic Time Baking/Roasting .....	16
Broiling In The Oven .....	17
Care And Cleaning .....	19-25
Control Knobs .....	19
Glass Surfaces .....	19
Porcelain Surfaces .....	19
Chrome Surfaces And Trim .....	19
Broiler Pan .....	19
Oven Racks .....	19
Lower Oven Interior .....	19
Self-Clean Oven Cycle .....	19
Oven Lights – Operation/Replacement ..	23
Removing And Replacing	
An Oven Door .....	24
Optional Oven Door Fronts .....	24
Adjusting The Temperature Control .....	25
For Service Or Assistance .....	26
KitchenAid Warranty .....	Back Cover

© 1989 KitchenAid, Inc.

# Important Safety Instructions

To reduce the risk of fire, electrical shock, injury to persons, or damage when using the oven, follow basic precautions, including the following:

1. Read all instructions before using the oven.
2. Install or locate the oven only in accordance with the provided Installation Instructions. It is recommended that the oven be installed by a qualified installer. The oven must be properly connected and grounded to electrical supply.
3. Do not use the oven for warming or heating the room. Persons could be burned or injured, or a fire could start.
4. Do not leave children alone in area where the oven is in use. They should never be allowed to sit or stand on any part of the oven. They could be burned or injured.
5. Do not wear loose or hanging garments when using the oven. They could ignite if they touch a heating element and you could be burned.
6. Do not repair or replace any part of the oven unless specifically recommended in this manual. All other servicing should be referred to a qualified technician.
7. Do not store flammable materials in or near the oven. They could explode or burn.
8. Do not use water on grease fires. Never pick up a flaming pan. Smother flaming pan by covering with a well-fitted lid, cookie sheet or flat tray. Flaming grease outside of pan can be extinguished with baking soda or, if available, a multipurpose dry chemical or foam-type extinguisher.
9. Use only dry potholders. Moist or damp potholders on hot surfaces may result in burns from steam. Do not let potholder touch hot heating elements. Do not use a towel or bulky cloth for a potholder. They could catch on fire.
10. Use care when opening oven door. Let hot air or steam escape before removing or replacing food.
11. Do not heat unopened containers. They could explode. The hot contents could cause burns and container particles could cause injury.
12. Keep oven vents unobstructed.
13. Always position oven racks in desired location while oven is cool. If rack must be moved while oven is hot, do not let potholder contact hot heating element in oven.
14. Do not clean door gasket. It is essential for a good seal. Care should be taken not to rub, damage, or move the gasket. Clean only parts recommended in this manual.
15. Do not use oven cleaners. No commercial oven cleaner or oven liner protective coating of any kind should be used in or around any part of the oven.

continued on next page

16. Before self-cleaning the oven, remove broiler pan, broiler grid, oven racks and other utensils. Do not use your oven to clean miscellaneous parts.
17. Do not store things children might want above the oven. Children could be burned or injured while climbing on it.
18. Do not touch heating elements or interior surfaces of oven. Heating elements may be hot even though they are dark in color. Interior surfaces of an oven become hot enough to cause burns. During and after use, do not touch, or let clothing or other flammable materials contact heating elements or interior surfaces of oven until they have had sufficient time to cool. Other surfaces of the oven may become hot enough to cause burns; such as, the oven vent opening, the surface near the vent opening, the oven door, and the oven door window.

– FOR YOUR SAFETY –

**DO NOT STORE OR USE GASOLINE OR OTHER FLAMMABLE VAPORS AND LIQUIDS IN THE VICINITY OF THIS OR ANY OTHER APPLIANCE. THE FUMES CAN CREATE A FIRE HAZARD OR EXPLOSION.**

– SAVE THESE INSTRUCTIONS –

## *You Are Responsible For*

- Installing the oven where it is protected from the elements, and in a wall or cabinet strong enough to support its weight. (See the Installation Instructions.)
- Making sure the oven is not used by anyone unable to operate it properly.
- Properly maintaining the oven.
- Using the oven only for jobs expected of a home oven.

# Ownership Registration

Please fill out and mail your Ownership Registration Card packed with the product. This card will enable us to contact you in the unlikely event of a product safety notification and assist us in complying with the provisions of the Consumer Product Safety Act. Return of this card is not necessary to validate your warranty.

You must provide proof of purchase or installation date for in-warranty service.

Write down the following information. You will need it if your oven ever requires service.

**Model Number\*** \_\_\_\_\_

**Serial Number\*** \_\_\_\_\_

**Date Purchased** \_\_\_\_\_

**Date Installed** \_\_\_\_\_

**Bullder's or Dealer's Name** \_\_\_\_\_

**Address** \_\_\_\_\_

**Phone** \_\_\_\_\_

\*Model and serial numbers are located on the lower left side of the door opening on the single/upper oven.

# Built-In Oven Features

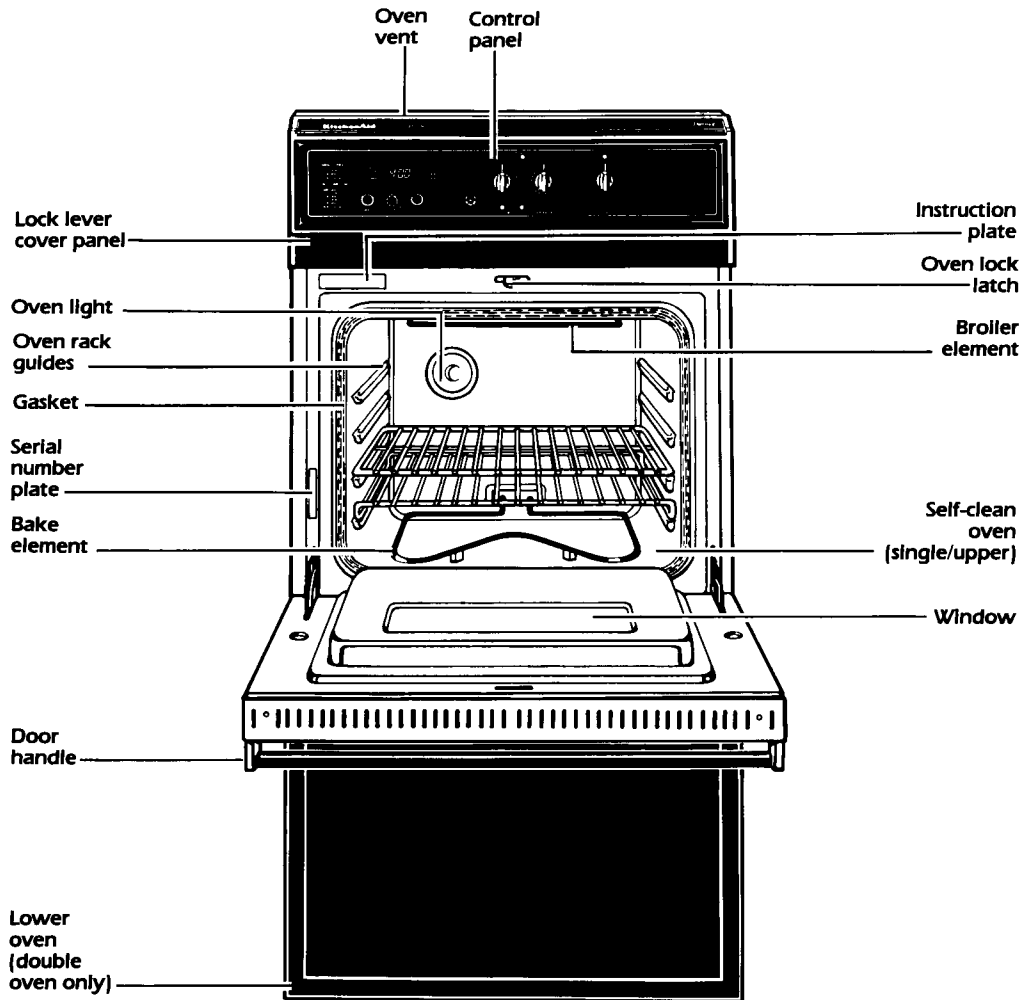

# Double Oven Control Panel

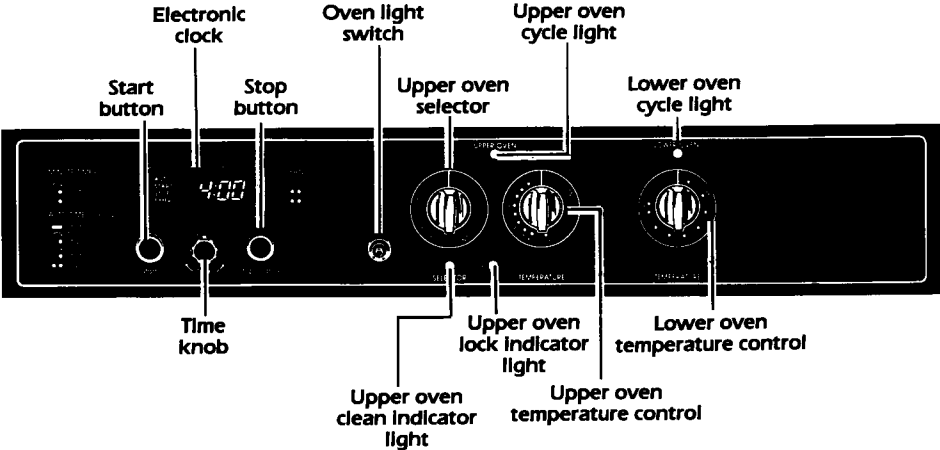

# Single Oven Control Panel

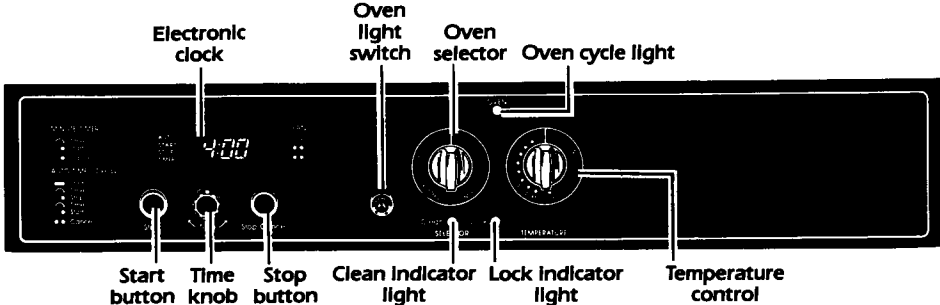

# Using the Oven

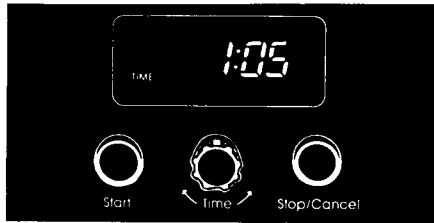

## Electronic Clock Operation

The electronic clock controls all timed operations for the single/upper oven. It consists of the Display Window, START button, TIME knob and STOP/CANCEL button. When your oven is first connected to the power in your home, "00:00" will appear in the Display Window.

### To set the time of day:

1. Turn the TIME knob to the left until a tone is heard and "TIME" appears in the Display Window. The previously set time (or "12:00") will appear in the Display Window.
2. Continue turning the TIME knob in either direction until the correct time of day appears in the Display Window.
3. Press the START button to begin clock operation.

### To use the minute timer:

The Minute Timer can be programmed from 5 seconds to 99 minutes for precise timing of short and long-term cooking, or any other activity. The Minute Timer is only an audible reminder and will not turn the oven ON or OFF.

1. To use, turn the TIME knob to the right. The Display Window will immediately change to ":05" and "TIMER" will be displayed.
2. Continue turning the TIME knob until the desired time is displayed (in minutes and seconds) in the Display Window.
3. To start the Minute Timer, press the START button.

The Display Window will continue to show "TIMER" and the selected time will begin counting down. At the

end of the timed period, "TIMER" will appear in the Display Window and flash rapidly and a tone will sound for 3 seconds, after which an intermittent tone will sound until the Minute Timer is cancelled, or until a total of 15 minutes have elapsed.

**IMPORTANT:** The current time of day may be checked while the Minute Timer is in use by touching the START button. The time of day will be displayed for 7 seconds, then return to the Minute Timer program in progress.

Press the STOP/CANCEL button once to turn off the alarm at the end of the Minute Timer program.

To cancel a Minute Timer program in progress, press the STOP/CANCEL button once. A tone will sound and the clock will return to the time of day.

When turning the TIME knob to set the Minute Timer, the time will appear in the Display Window and increase in the following increments:

From 5 seconds to 2 minutes	5 second increments
From 2 minutes to 10 minutes	10 second increments
From 10 minutes to 20 minutes	30 second increments
From 20 minutes to 99 minutes	1 minute increments

**IMPORTANT:** The Minute Timer may be used at the same time as an Automatic Time Cooking or Self-Clean program. The Time Cooking or Self-Clean program must be set first, then the Minute Timer. One touch of the STOP/CANCEL button will cancel the Minute Timer and two touches will cancel the cooking or cleaning program.



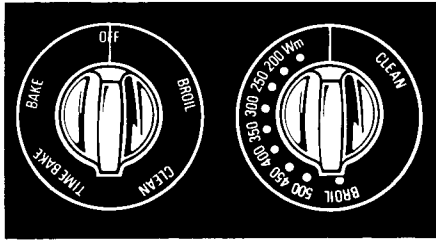

## Single/Upper Oven Controls

The single/upper oven can be used for baking, roasting and broiling. The oven has two controls – a Selector and a Temperature Control. Both must be set for the oven to work.

### The selector has five settings:

**BROIL** – The top elements will operate at full power whenever heating. Use this setting for broiling.

**CLEAN** – Use this setting for self-cleaning only.

**TIME BAKE** – The bottom element and outer top element operate at full power and glow red whenever heating. Use this setting for Automatic Time Baking.

**BAKE** – The bottom element and outer top element operate at full power and glow red whenever heating. Use this setting for baking, roasting and casseroles.

**OFF** – Use this setting to turn the oven off.

### Temperature control:

The Temperature Control can be set at any temperature from **WARM** (150°F) to **BROIL** (550°F), or on **CLEAN**. Settings **WARM** to 225°F are suggested for warming and holding foods. Be sure the Temperature Control is turned fully counterclockwise when the oven is not in use.

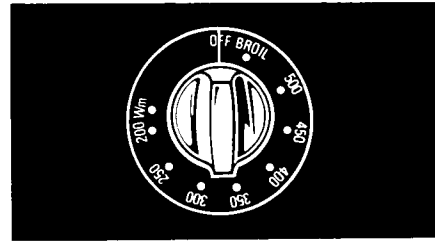

## Lower Oven Control (For Double Ovens)

The lower oven can be used for baking, roasting and broiling. It is controlled by a single Temperature Control, with settings from **WARM** (150°F) to **BROIL** (550°F). Be sure the Temperature Control is turned to **OFF** when the oven is not in use.

**IMPORTANT:** The lower oven will not operate while the upper oven is being cleaned.

## Preheating The Oven

For best results, preheat the oven until the Oven Cycle Light goes out, unless the recipe states otherwise. Set the Selector to **BAKE** and the Temperature Control to the desired temperature.

Exercise care in turning the Temperature Control so you do not go past the desired set point. If you accidentally go past the desired setting, turn the dial fully counterclockwise and then reset to the desired setting to get an accurate temperature setting. The Oven Cycle Light will go out when the desired temperature has been reached and will cycle on and off with the elements during the heating period.

Be sure the Selector is turned to **OFF** and the Temperature Control is turned fully counterclockwise or to **OFF** when the oven is not in use.

## Baking In The Oven

### Single/upper oven:

1. Arrange the oven racks in the desired positions.
2. Turn the Selector to BAKE.
3. Set the Temperature Control to the recommended temperature. See the "Baking chart" on page 12.
4. Place the food in the oven after the Oven Cycle Light goes out, or when the recipe specifies.

Be sure to turn the Selector to OFF and the Temperature Control fully counterclockwise when cooking has been completed.

### Lower oven (for double ovens):

1. Arrange the oven racks in the desired positions.
2. Set the Temperature Control to the recommended temperature. See the "Baking chart" on page 12.
3. Place the food in the oven after the Oven Cycle Light goes out, or when the recipe specifies.

Be sure to turn the Temperature Control to OFF when cooking has been completed. The oven will remain ON if left at any other setting.

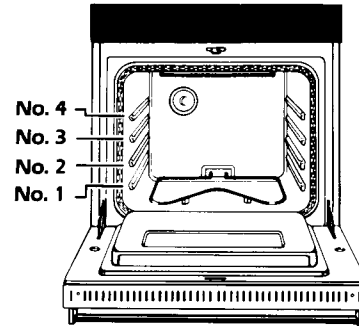

### Rack positions:

There are two racks for each oven. One rack is straight and the other is offset. The offset rack permits intermediate positions for the placement of food within the oven.

Your KitchenAid oven has four rack positions. Rack position 4 is the highest position, or farthest from the bottom of the oven. Rack position 1 is the lowest position, or closest to the bottom of the oven. Be sure to arrange the oven rack(s) before putting foods into the oven or turning the oven on.

### To remove oven racks:

1. Pull rack out until bar on back of rack touches first stop.
2. Lift front of rack up until rear position of rack slides out between the two front stops.

### **Baking tips:**

- Set the oven controls and, if necessary, preheat the oven until the Oven Cycle Light goes out before placing pans in the oven. Avoid opening the oven during baking. Heat is lost and could cause poor baking results.
- Use the Minute Timer to time cooking functions. (See page 12 for recommended baking times.)
- Wait until the shortest recommended baking time is over before checking food.
- When baking with two sheets of cookies at the same time, each sheet should be removed when the desired degree of doneness is reached, which may be at separate times.

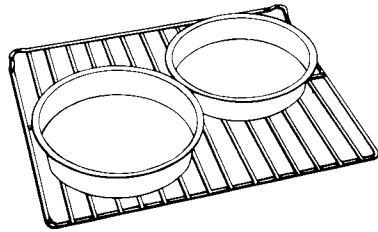

### **Pan placement:**

- If possible, use only one rack during baking if the pan covers most of the rack, such as a large cookie sheet.
- Stagger pans in opposite directions when two racks and several pans are used. No pan should be directly above another.
- Allow 1 1/2 to 2 inches of air space around all sides of each pan for even air circulation.
- When using a large roasting pan or cookie sheet, turn the pan so that the long side is parallel to the oven door for the best heat distribution and air flow.

### **Bakeware tips:**

- Use the recommended pan size given in recipes to insure good results. Old or darkened pans are not desirable.
- Tin coated, stainless steel, warped or dented pans do not heat evenly and will cause uneven baking.
- Bake cakes, cookies, quick breads and muffins in shiny pans for a tender, golden crust.
- Reduce oven temperature by 25°F when using glass pans, except when baking pies or yeast breads.
- Cookies, biscuits and cream puffs bake best on medium weight aluminum sheets with no sides or very low sides.

### **Using aluminum foil correctly in the oven:**

Use aluminum foil to catch spillovers from pies or casseroles.

- Place the foil on the oven rack below the rack with the food. The foil should have the edges turned up and be about 1 inch (3 cm) larger all around than the dish holding the food.
- Do not cover the entire rack with aluminum foil. It will reduce air circulation and cause poor cooking results.

#### **Electrical Shock Or Fire Hazard**

- **Do not allow foil to touch the heating elements because it will damage them and could result in electrical shock or fire hazard.**
- **Do not line Self-Clean oven bottoms or entire oven rack with foil. Poor baking will result. Damage to the oven finish will occur if left in oven during Self-Clean cycle.**

**Baking chart:**

<b>FOOD</b>	<b>OVEN TEMPERATURE</b>	<b>APPROXIMATE COOKING TIME</b>
<b>Breads, yeast</b>		<b>(Min.)</b>
• loaf	375°F	30 – 40
• rolls, pan	400°F	12 – 15
<b>Breads, quick</b>		
• biscuits	450°F	10 – 15
• muffins	400°F	20 – 25
• popovers	450°F	20 – 25
• corn bread	425°F	25 – 30
• nut bread	350°F	60 – 75
• gingerbread	350°F	25 – 30
<b>Cakes</b>		
• angel food	375°F	30 – 40
• layer cake	350 – 375°F	20 – 30
• loaf cake	350°F	35 – 45
• sponge cake	350°F	35 – 45
• pound cake	350°F	35 – 45
• fruit cake	300°F	2 – 2½ hrs.
• sheet cake	300°F	25 – 35
<b>Cookies</b>		
• drop	375°F	10 – 15
• rolled and refrigerated	375°F	8 – 12
• chocolate	375°F	10 – 15
• fruit and molasses	375°F	10 – 15
• brownies	350°F	20 – 30
• macaroons	350°F	12 – 15
<b>Miscellaneous</b>		
• apples, baked	375°F	50 – 60
• beans, baked	300°F	5 – 6 hrs.
• custard, cup	325°F	35 – 40
• potatoes, baked	400°F	75
• pudding		
bread	350°F	45 – 60
cottage	375°F	30 – 40
rice	325°F	40 – 60
• scalloped dishes	350°F	60 – 90
• souffle	350°F	50 – 60
<b>Pastries</b>		
• cream puffs	400°F	35 – 40
• custard and pumpkin pie	350°F	30 – 40
• pastry shell	450°F	10 – 12
• two crust fruit pie		
cooked filling	400°F	25 – 30
uncooked filling	400°F	40 – 50
• meringue topping	350°F	10 – 15

**High altitude baking:**

When baking at high altitudes, recipes and baking times vary. For accurate information, write the Extension Service of your state college or university or Extension Service, Colorado State University, Fort Collins, Colorado, 80523. There may be a cost for the bulletins. Be sure to specify the type of information you want (i.e., cakes, cookies, breads, etc.).

**Common baking problems:**

The following information will help if you are having baking problems.

**Cakes burn on the sides when:**

- There were too many pans or the pans were too large for the oven.
- The oven was too hot.

**Cakes crack on the top when:**

- The batter was too thick.
- The pan was not the correct size.
- The pan was not centered in the oven.

**Cakes rise higher on one side when:**

- The batter was spread unevenly in the pan.
- The pans were set too close to the sides of the oven.
- The oven was not level.
- The pans were warped.

**Cookies and biscuits brown more on one side than the other when:**

- The pan was set too close to one side of the oven.
- The oven door was not closed properly.

**Cookies and biscuits are too brown on top when:**

- The pan was set too high in the oven.
- The Selector was left on BROIL during baking.
- Aluminum foil was used. The foil may have distributed the heat unevenly in the oven.
- The pan's sides were too deep.
- The pan was too wide or too long for the oven.
- The oven rack was overcrowded. See "Pan placement" on page 11.

**Pies burn around the edges when:**

- The oven was too hot.
- There were too many pans or the pans were too large for the oven.
- The pans were too dark.

**Pies are too light in color on the top when:**

- The oven was not hot enough.
- The oven was too full, cutting off even heat distribution.

## Roasting In The Oven

Roasting is a dry heat cooking method. It is recommended for poultry and tender cuts of beef, lamb, pork and veal.

### Single/upper oven:

1. Arrange the oven racks in the desired positions and place the food in the oven.
2. Turn the Selector to BAKE.
3. Set the Temperature Control to the recommended temperature. See the "Roasting chart" on page 15.

Be sure the Selector is turned to OFF and the Temperature Control is turned fully counterclockwise when cooking has been completed.

### Lower oven (for double ovens):

1. Arrange the oven racks in the desired positions and place the food in the oven.
2. Set the Temperature Control to the recommended temperature. See the "Roasting chart" on page 15.

Be sure to turn the Temperature Control to OFF when cooking has been completed. The oven will remain ON if left at any other setting.

### Roasting tips:

- Roast meats fat side up in a shallow pan using a roasting rack.
- Use a roasting pan that fits the size of the food to be roasted. Meat juices may overflow the sides of a pan that is too small. Too large of a pan will result in increased oven spatter.
- Spatter can be reduced by lining the bottom of the roasting pan with lightly crushed aluminum foil.

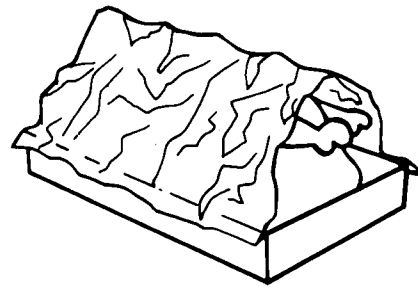

- A foil tent will slow down surface browning for long-term roasting, as when roasting a turkey. Place tent-shaped foil loosely over meat to allow for air circulation. Do not seal foil or meat will be steamed.
- Use an accurate meat thermometer to determine when meat has reached desired degree of doneness. Insert the thermometer into the center of the thickest portion of the meat or inner thigh or breast of poultry. For an accurate reading, the tip of the thermometer should not touch fat, bone or gristle.
- After reading the thermometer once, push it further into the meat 1/2 inch or more and read again. If the temperature drops, return the meat to the oven for more cooking.
- Remove roasted meats from the oven when the thermometer registers 5°F to 10°F lower than the desired doneness. The meat will continue to cook after removal from the oven.
- Roasts will be easier to carve if allowed to stand 10 to 15 minutes after removal from the oven.

**Roasting chart:**

Roast at oven temperature of 325°F.\*\* Preheat not needed.

MEAT	APPROXIMATE WEIGHT	APPROXIMATE MINUTES PER POUND	MEAT THERMOMETER TEMPERATURE
<b>Beef</b>			
• rolled rib	4 – 6 lbs.		
rare		30	140°F
medium		35	150°F
well done		45	170°F
• standing rib	6 – 7 lbs.		
rare		25	140°F
medium		30	150°F
well done		40	170°F
• rump roast	4 – 6 lbs.		
medium		25	150°F
well done		30	170°F
<b>Lamb</b>			
• leg, half	3 – 4 lbs.	35	180°F
	6 – 7 lbs.	30	180°F
<b>Pork</b>			
• loin	4 – 5 lbs.	35	170°F
• shoulder	4 – 5 lbs.	40	185°F
• ham, fully cooked	3 – 5 lbs.	18	130°F
	8 – 10 lbs.	15	130°F
<b>Poultry</b>			
• chicken**	3 – 4 lbs.	30	185°F*
	5 – 7 lbs.	30	185°F*
• duck	10 – 12 lbs.	25	*
• goose	6 – 10 lbs.	25	*
• turkey, unstuffed	10 – 16 lbs.	20	180°F
	18 – 25 lbs.	18	180°F
<b>Veal</b>			
• loin	3 – 4 lbs.	35	170°F
• shoulder	5 – 6 lbs.	45	170°F

\*The muscles may not be large enough to use a thermometer.

\*\*For chicken, set the oven temperature to 375°F.

## Automatic Time Baking/ Roasting (Single/Upper Oven)

Using the TIME BAKE setting allows you to turn the single/upper oven on and off automatically. The starting time can be set for now or later in the day. On double oven models, only the upper oven can be set to Automatic Time Bake.

1. Arrange oven racks in desired positions and place food in the oven.

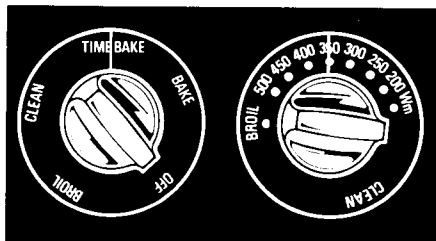

2. Turn the Selector to TIME BAKE and set the Temperature Control to the desired temperature.
3. Check to see that the electronic clock is set to the correct time of day. If not, reset to the correct time following the instructions on page 8.



4. Set the start time. Touch the START button and hold down for 2 seconds. "START TIME" will appear in the Display Window and a short tone will sound.
5. To start cooking now, touch the START button again to lock in the start time and go to the next step.

To start cooking later, turn the TIME knob until the desired start time appears in the Display Window, then touch the START button again to lock in the start time.

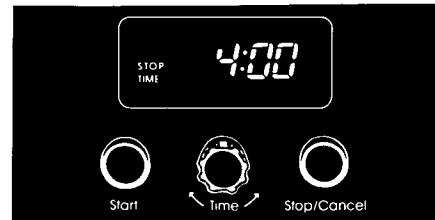

6. Set the stop time. After the start time is set, "STOP TIME" will appear in the Display Window and a short tone will sound. Turn the TIME button until the desired stop time appears in the Display Window. Touch the START button again to lock in the stop time and begin the program.



7. "AUTO" will appear continuously in the Display Window if the Automatic Time Bake cycle has been programmed to start now. "AUTO" will flash in the Display Window if the Automatic Time Bake cycle has been programmed to start later. "AUTO" will change from flashing to continuous when the programmed start time is reached.



**To avoid sickness and food waste when using Automatic Time Bake:**

- Do not use foods that will spoil while waiting for cooking to start, such as dishes with milk or eggs, cream soups, and cooked meats or fish. Any food that has to wait for cooking to start should be very cold or frozen before it is put in the oven. **MOST UNFROZEN FOODS SHOULD NEVER STAND MORE THAN TWO HOURS BEFORE COOKING STARTS.**
- Do not use foods containing baking powder or yeast when using delay start. They will not rise properly.
- Do not allow food to remain in oven for more than two hours after end of cooking cycle.

**What happens during the time bake selection?**

- The oven will come on at the time selected and maintain the temperature set on the Temperature Control until the selected stop time.
- At the end of the cooking period, the oven will shut off. A tone will sound for three seconds, followed by an intermittent tone until the STOP/CANCEL button is touched or a total of 15 minutes have elapsed. Foods should be removed from the oven when the cooking time has ended, or they will tend to overcook.

**To review a program:**

Press and hold the START button for the start time or the STOP/CANCEL button for the stop time for two seconds. The start or stop time will appear in the Display Window for seven seconds.

If you wish to change the start or stop time after a cooking program has been entered, press and hold the START button for the start time or STOP/CANCEL button for the stop time for three seconds. Turn the TIME knob to the new desired time, then touch the START button to lock in the new time.

**To cancel automatic time bake:**

If you wish to cancel Automatic Time Bake while in progress, touch the STOP/CANCEL button twice. A tone will sound each time and the clock will return to the present time of day. The oven will automatically turn itself off. If you wish to continue cooking in the oven, the Selector must be manually reset to BAKE.

**Broiling In The Oven**

Broiling is a quick-cook method that will produce foods that are brown on the outside and moist and juicy on the inside.

**Single/upper oven:**

1. Arrange the oven racks in the desired positions. See "Broiling chart" on page 18.
2. Place food on grid on broiler pan and place in center of the oven rack. Turn the pan so that the long side is parallel to the oven door for the best heat distribution and air flow.
3. Turn the Selector to BROIL. Do not preheat the broiler.
4. Set the Temperature Control to the recommended temperature. See "Broiling chart" on page 18.
5. Position the oven door at the broil stop position.

Be sure to turn the Selector to OFF and the Temperature Control fully counterclockwise when broiling has been completed.

**Lower oven (for double ovens):**

1. Arrange the oven racks in the desired positions. See "Broiling chart" on page 18.
2. Place food on grid on broiler pan and place in center of the oven rack.
3. Set the Temperature Control to BROIL (550°F).
4. Position the oven door at the broil stop position.
5. Door can remain closed during broiling, however results may differ.

Be sure to turn the Temperature Control to OFF when broiling has been completed.

**Broiling tips:**

- Always start broiling with a cold broiler pan for even results.
- To retain more natural juice, do not pierce meat with fork.
- Trim the outer layer of fat from steaks and chops.
- Slit fatty edges to prevent meat from curling during broiling.

**Broiling chart:**

The recommended rack position is numbered lowest (1) to highest (4)

FOOD	FLAT RACK POSITION	TEMPERATURE CONTROL SETTING (SINGLE/UPPER OVEN)	APPROXIMATE TOTAL TIME (MINUTES)
<b>Steak, 1" thick</b>	3		
• rare		BROIL	8 – 10
• medium		BROIL	10 – 12
• well done		BROIL	12 – 15
<b>Steak, 1 1/2" thick</b>	3		
• rare		BROIL	10 – 12
• medium		BROIL	12 – 15
• well done		BROIL	15 – 17
<b>Hamburger patties</b>	4	BROIL	6 – 10
<b>Lamb chops, 1" thick</b>	3	400°F	20 – 30
<b>Ham slice, 1" thick</b>	3	BROIL	20 – 25
<b>Bacon</b>	3	400°F	5 – 7
<b>Frankfurters</b>	3	400°F	10 – 12
<b>Chicken pieces</b>	1 or 2	400°F	40 – 50
<b>Fish</b>	2	350°F	20 – 25
<b>Calves liver</b>	3	350°F	8 – 10
<b>Tomato halves</b>	3	BROIL	8 – 10
<b>Orange or grapefruit halves</b>	2	BROIL	8 – 15

- Brush food with butter, sauce or seasoning, if desired, several times during broiling.
- Grease the broiler pan grid when broiling fish to prevent sticking.

**IMPORTANT:** To prevent accidental locking, the upper/single oven Oven Lock Lever should always be unlocked (positioned to the far left) except when the Selector and Temperature Control are in the CLEAN mode. If accidental locking occurs, turn oven off. Allow oven temperature to decrease so Lock Lever can be moved. Do not force Lock Lever. Wait until it moves easily.

**Fire Hazard**

**Covering the broiler grid with foil is not recommended. Poor drainage of grease may result in a fire. If foil is used, cut slits in foil to correspond with all openings in broiler grid. Grease can then drain away and cool in pan.**

# Care and Cleaning

Several finishes have been used on this oven. To prevent damage to these finishes, follow the suggested cleaning method(s) for that finish.

**IMPORTANT:** Some finishes can be damaged from harsh and abrasive cleaning agents.

**Burn Or  
Electrical Shock Hazard**  
Make sure all controls are OFF and the oven is COOL before cleaning. Failure to do so can result in burns or electrical shock.

## Control Knobs

Pull the control knobs straight off. Wash with detergent and hot water, then rinse well. Dry completely and replace by pushing them firmly into place.

**IMPORTANT:** Make sure all the control knobs either point to the OFF position, or are turned fully counterclockwise.

## Glass Surfaces

Clean surface with detergent and hot water. Rinse and dry well. Use mild glass cleaner to remove fingermarks.

## Porcelain Surfaces

Clean surface with detergent and hot water. Rinse and dry with soft cloth.

## Chrome Surfaces And Trim

Clean with soap and hot water. Rinse and dry well. Use mild glass cleaner to remove fingermarks. For stubborn spots, clean with an ammonia solution of 1 cup ammonia to 2 gallons of water.

## Broiler Pan

Clean with detergent and hot water. For stubborn spots, use a soap-filled steel wool pad with plenty of water. Rinse well.

## Oven Racks

Clean with detergent and hot water. For stubborn spots, soak in ammonia solution of 1 cup ammonia to 2 gallons of water.

## Lower Oven Interior (Double Oven)

Clean with detergent and hot water. Rinse well with clear water and dry with a soft towel. To remove heavy soil use commercial oven cleaner or scouring pad.

## Self-Clean Oven Cycle (Single/Upper Oven)

The Self-Clean cycle is designed to eliminate the need for scrubbing and scouring soil baked onto the oven interior. Food spatters on the oven wall become harder to remove each time the oven is heated, but because the Self-Clean cycle heats these soils to a higher temperature (850°F – 900°F), the soil is burned off.

Your KitchenAid oven offers a variable time Self-Clean cycle to give you excellent flexibility when self-cleaning your oven. The length of cleaning time can be set to meet your cleaning needs. A 2½ hour Self-Clean cycle is usually ample to clean a moderately soiled oven. A 4 hour Self-Clean cycle is suggested for an oven with heavy soil build-up. The Self-Clean cycle can also be delayed to a more convenient time if desired.

continued on next page

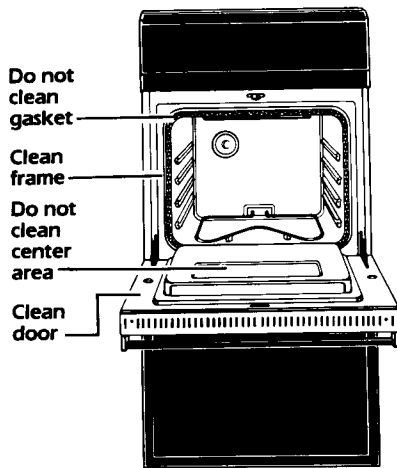

**Before starting a self-clean cycle:**

1. Turn oven light off on the control panel before using the Self-Clean cycle to extend oven light bulb life.
2. Remove all items and the oven racks from the oven. It is recommended that the oven racks be removed as they will discolor and darken during the Self-Clean cycle. If the oven racks remained in the oven during the Self-Clean cycle, wipe the sides with vegetable oil after cleaning so they will slide more easily. Broiler pan, broiler grid or cooking utensils should not be cleaned in the oven. Heavy grease build-up on these items will produce smoke which can be discharged into the kitchen.
3. Wipe up large spillovers in the oven cavity with a damp cloth. The bottom element is hinged for easier cleaning of the cavity floor. Never use chemical oven cleaners inside a self-cleaning oven or on raised portion of the door.

**IMPORTANT:** The bottom element must be in the down position before beginning the Self-Clean cycle.

The smoke eliminator will handle the normal flow of odors during the Self-Clean cycle. However, minor smoke may be noticed when soil build-up is heavy.

**IMPORTANT:** Some smoke may occur during the very first cleaning cycle due to burn-off of binders in oven insulation.

4. Wipe soil from oven frame area outside of gasket, and inside the oven door. Wash with detergent and hot water. (The center area of the door does not need to be hand cleaned. Do not clean, move or bend gasket. Poor cleaning and baking may result.) Rinse well with mixture of vinegar and water and wipe dry. A non-scratch scouring pad may be used on heavily soiled areas. Wash surfaces frequently to minimize overall cleaning as these areas are not cleaned during the Self-Clean cycle.

**IMPORTANT:** The lower oven will not operate while the upper oven is being cleaned.

**Personal Injury And Product Damage Hazard**

- Do not touch the oven during the Self-Cleaning cycle. It could burn you.
- Do not use commercial oven cleaners in your oven. Cleaners may produce hazardous fumes or damage the porcelain finish.
- Do not force the Lock Lever, you could bend or break it. The lever is designed to stay locked until the oven is cool enough to safely open. Wait until it moves freely.
- Do not use foil or other liners in the oven. During the Self-Cleaning cycle foil can burn or melt and damage the oven surface.
- Do not block the vent during the Self-Cleaning cycle. Air must move freely for best cleaning results.

### Starting the automatic self-clean cycle:

1. Follow steps under "Before starting a self-clean cycle."
2. Check to see that the electronic clock is set to the correct time of day. If not, reset to the correct time following the instructions on page 8.

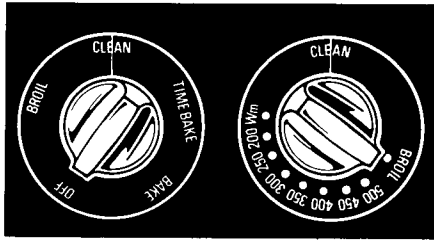

3. Set the Selector to CLEAN and turn the Temperature Control fully clockwise to CLEAN.
4. Lift the Lock Lever Cover Panel between the oven door and the control panel. Slide the Oven Lock Lever all the way to the right. You will hear a beep and "START TIME" will appear in the Display Window.

**IMPORTANT:** To prevent accidental locking, the upper/single oven Oven Lock Lever should always be unlocked (positioned to the far left) except when the Selector and Temperature Control are in the CLEAN mode. If accidental locking occurs, turn oven off. Allow oven temperature to decrease so Lock Lever can be moved. Do not force Lock Lever. Wait until it moves easily.



5. Touch the START button to lock in the present time of day as the start time. "STOP TIME" and the actual cleaning stop time, 2½ hours from the present time of day, will appear in the Display Window.

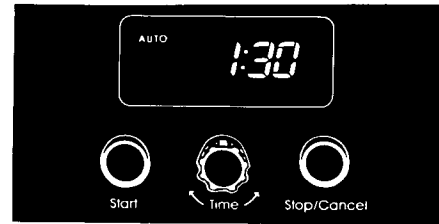

6. Touch the START button to lock in the automatically selected stop time and return the clock to the present time of day. "AUTO" will appear in the Display Window. The Clean Indicator Light will glow, and the cleaning cycle will begin. No end of cycle tone will be given.
7. At the end of the Self-Clean cycle, the Clean Indicator Light and "AUTO" will go out.

### Delaying the automatic self-clean cycle:

The start of the Self-Clean cycle can be postponed to a more convenient time, if desired. The controls may be set to delay the Self-Clean cycle for up to twelve hours.

1. Follow steps 1, 2, 3 and 4 under "Starting the automatic self-clean cycle."
2. Turn the TIME knob until the desired new start time appears in the Display Window.
3. Touch the START button to lock in the new start time. "STOP TIME" and the actual cleaning stop time, 2½ hours from the selected start time, will appear in the Display Window.
4. Touch the START button to lock in the stop time and return the clock to the present time of day. "AUTO" will flash in the Display Window until the Self-Clean cycle begins. Once the cycle is in progress, "AUTO" will appear continuously. No end of cycle tone will be given.

### **Extending the automatic self-clean cycle:**

If your oven is excessively dirty and requires longer cleaning time, the Automatic Self-Clean cycle can be extended for up to 4 hours.

1. Follow steps 1, 2, 3 and 4 under "Starting the automatic self-clean cycle."
2. When "STOP TIME" appears in the Display Window, turn the TIME knob to the right until the desired length of cleaning time is displayed. Remember, you will be adding time to the normal 2½ hour cleaning time.

**IMPORTANT:** A self-cleaning time longer than 4 hours cannot be selected.

3. Touch the START button to lock in the new stop time and return the clock to the present time of day.
4. "AUTO" will appear in the Display Window and the Self-Clean cycle will begin. No end of cycle tone will be given.

### **Combining the delayed and extended self-clean cycle options:**

An Automatic Self-Clean cycle can be both delayed and extended, if desired.

1. Follow steps 1, 2, 3 and 4 under "Starting the automatic self-clean cycle."
2. Set the delayed start time by turning the TIME knob until the new start time appears in the Display Window.
3. Touch the START button to lock in the new start time. "STOP TIME" and the actual cleaning stop time, 2½ hours from the selected start time, will appear in the Display Window. Turn the TIME knob until the new cleaning stop time appears in the Display Window. 4 hours is the longest cleaning time that can be selected.
4. Touch the START button again to lock in the new stop time and return the clock to the present time of day.

5. "AUTO" will flash in the Display Window until the Self-Clean cycle begins. Once the cycle is in progress, "AUTO" will appear continuously. No end of cycle tone will be given.

### **What happens during the self-clean cycle?**

The oven not being cleaned will not heat even though the controls are set.

After the controls have been set on a non-delayed cycle, or after the delayed time has elapsed on a delayed cycle:

- The Oven Cycle Light will glow to tell you the oven is ON.
- The Clean Indicator Light will glow to tell you the oven is slowly heating to the clean temperature, and "AUTO" will appear continuously in the Display Window.
- The Lock Indicator Light will come on when the temperature reaches 575°F – 600°F (approximately 15 minutes).

At the end of the Self-Clean cycle:

- The Clean Indicator Light will go out.
- The Lock Indicator Light will continue to glow until the oven temperature drops below 550°F. The oven door cannot be opened until the Lock Indicator Light goes out. Do not turn Temperature Control or Selector to "OFF" until Lock Indicator Light goes out.

### **To stop the self-clean cycle at any time:**

1. Touch the STOP/CANCEL button twice. A tone will sound each time and the clock will return to the present time of day.
2. Slide Oven Lock Lever all the way to the left.

**IMPORTANT:** If the Lock Indicator Light has come on, wait until oven cools and light goes off before sliding Lock Lever back to the left.

**Do not force it. Wait until it moves easily.**

3. Turn the Selector to OFF and the Temperature Control fully counterclockwise.

**To return oven to regular use after a self-clean cycle:**

1. Slide the Oven Lock Lever all the way to the left.
2. Turn the Selector to OFF and the Temperature Control fully counterclockwise.
3. Allow oven to cool sufficiently before wiping up any residue.

**Oven self-cleaning tips:**

- Evening is a good time to clean the oven, after normal oven use is completed.
- Small amounts of smoke escaping from the oven vent are normal when oven is heavily soiled. Excessive smoke may indicate heavy spillovers have not been wiped up.
- **Do not** force the Oven Lock Lever open when the Lock Indicator Light is on. Damage to the lock mechanism may result.
- Clean the single/upper oven regularly, before it becomes "excessively dirty." If oven is not clean after one cycle, repeat the Self-Clean cycle.
- After a Self-Clean cycle, any powdery residue can be wiped away with a damp cloth. If white spots remain in the oven after a Self-Clean cycle, remove them with a non-scratch scouring pad before using the oven again. These spots are usually salt residues that cannot be removed during the Self-Clean cycle.
- If the soil removal was not complete, increase the length of the clean time in the next cycle.

**Oven Lights –  
Operation/Replacement**

Oven light(s) automatically come on in the oven(s) when an oven door is opened. The light(s) can be turned on when the doors are closed by pushing the Oven Light Switch on the control panel.

**Replacing a light bulb:**

**Electrical Shock And  
Personal Injury Hazard**

- **Make sure oven and light bulb are cool and power to the oven has been turned OFF before replacing the light bulb. Failure to do so could result in electrical shock or burns.**
- **The lens must be in place when using the oven. The lens protects the bulb from breaking, and from high oven temperatures. Broken glass could cause injury.**

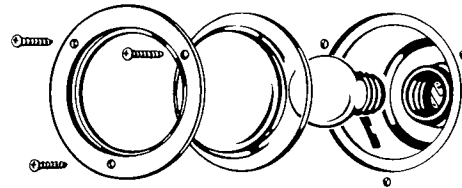

1. Turn the power off at the main power supply.
2. Remove the three screws in the lens holder with a Phillips screwdriver. Care should be taken to prevent the holder and the lens from falling into the oven cavity.
3. Lift holder and glass lens out.
4. Remove and replace the light bulb with a 40-watt appliance bulb.
5. Replace the lens and the holder, and tighten the three screws.
6. Turn the power back on at the main power supply.

## Removing And Replacing An Oven Door

Both oven doors can be removed to change optional oven door fronts. **Do not** remove them for cleaning.

### Personal Injury Hazard

- Oven doors are heavy. Use both hands to remove the oven doors.
- Grasp only the sides of the oven door. Do not use any portion of the front frame or trim for lifting.

Failure to properly grasp the oven door could result in personal injury or product damage.

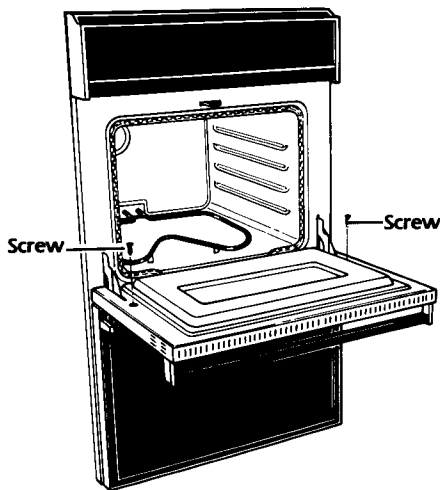

### To remove:

1. Open door completely.
2. Remove the two screws just above the oven door hinges.
3. Close door to the broil stop position (door will be open about 6 inches).
4. Hold the door firmly on both sides and lift the door up and out of the hinge slots to remove. Set the door aside.



### To replace:

1. Grasp door firmly on both sides. Slide the hinge slot in the bottom of the door over the hinges. Push the door down and in to replace.
2. Open the door slightly past the broil stop position and push it down to make sure the door is completely installed.
3. Open the door completely. Replace the two oven door screws.
4. Close and open the door slowly to make sure it is replaced properly.

**IMPORTANT:** The inside of Single/Upper Oven door has a slot for the Oven Lock Lever. Do not replace Lower Oven door on Upper Oven cavity, or damage to the interior finish may result from the Lock Lever hitting the door surface.

## Optional Oven Door Fronts

The front door glass can be changed to match your kitchen decor. The following front kits are available from your KitchenAid dealer: White Glass 24" (Kit No. 3177769), White Glass 27" (Kit No. 3177770), Almond Glass 24" (Kit No. 3177771) and Almond Glass 27" (Kit No. 3177772). Two kits are required for a double oven. These kits include easy installation instructions.



## Adjusting The Temperature Control

You may find the oven temperature to be lower or higher than you are used to. Your old oven may have shifted gradually while your new oven may be more exact. If, after using the oven, you are not satisfied with the temperature settings, they can be adjusted by following these steps:

1. Pull the Temperature Control knob straight off.
2. Loosen the screws  $\frac{1}{2}$  turn with a Phillips screwdriver.

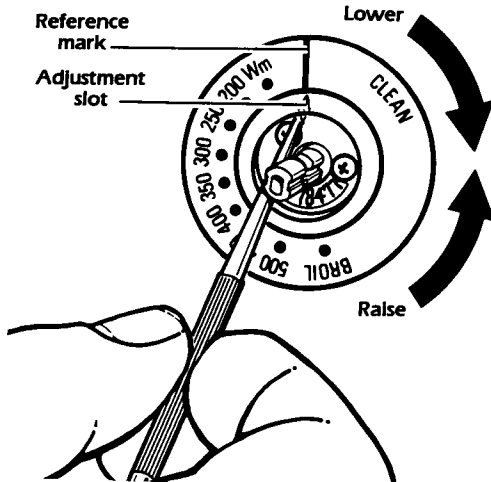

3. Put the blade of a small flat screwdriver into the slot of the temperature dial.
4. Use the screwdriver to rotate the temperature dial. The initial dial position is at "0" relative to the center hub reference mark. Each mark equals a 20°F change in temperature. Rotate the dial counterclockwise to raise the temperature, or clockwise to lower the temperature.
5. Tighten the screws and replace the knob.

# For Service or Assistance

## Follow these steps:

1. If your oven should fail to operate, review the following list before calling your dealer. You could save the cost of a service call.
  - Have instructions in this book been followed?
  - Has the fuse blown, or is the circuit breaker open?
  - Is the Selector set in the correct position?
  - Is Oven Lock Lever in proper position for cooking (left) or cleaning (right)?
  - Recheck suspected defect.
2. If the problem is not due to one of the above items, first call your dealer or repair service he recommends.
  - All service should be handled locally by the dealer from whom you purchased the oven or an authorized KitchenAid servicer.
3. In the event you are unable to obtain the name of a local authorized KitchenAid servicer, call KitchenAid Customer Relations, TOLL FREE: **800-422-1230**.
  - A Customer Relations representative can recommend a qualified service company in your area.

If you must call or write, please provide: Model Number, Serial Number, Date of Purchase and complete description of the problem. Write to:

Customer Relations Department  
KitchenAid, Inc.  
P.O. Box 558  
St. Joseph, MI 49085-0558

Please include a daytime phone number in your correspondence.
4. If you are not satisfied with the action taken, contact the Major Appliance Consumer Action Panel (MACAP). MACAP is a group of independent consumer experts that voices consumer views at the highest levels of the major appliance industry. Contact them only when the dealer, authorized servicer or KitchenAid Inc., have failed to resolve your problem.

Major Appliance Consumer  
Action Panel  
20 North Wacker Drive  
Chicago, IL 60606

MACAP will in turn inform us of your action.

# KitchenAid®

## Electric Built-In Oven Warranty

LENGTH OF WARRANTY:	KITCHENAID WILL PAY FOR:	KITCHENAID WILL NOT PAY FOR:
<b>ONE YEAR FULL WARRANTY FROM DATE OF INSTALLATION.</b>	Replacement parts and repair labor to correct defects in materials or workmanship. Service must be provided by an authorized KitchenAid servicing outlet.	A. Service calls to: <ol style="list-style-type: none"> <li>1. Correct the installation of the oven.</li> <li>2. Instruct you how to use the oven.</li> <li>3. Replace house fuses or correct house wiring.</li> </ol> B. Repairs when oven is used in other than normal home use. C. Damage resulting from accident, alteration, misuse, abuse, improper installation or installation not in accordance with local electrical codes. D. Any labor cost during the limited warranty. E. Replacement parts or repair labor costs for units operated outside the United States. F. Pickup and delivery. This product is designed to be repaired in the home.
<b>SECOND THROUGH FIFTH YEAR LIMITED WARRANTY FROM DATE OF INSTALLATION.</b>	Replacement parts for the electric element(s) to correct defects in materials or workmanship.	
<b>SECOND THROUGH TENTH YEAR LIMITED WARRANTY FROM DATE OF INSTALLATION.</b>	Replacement of the porcelain oven cavity/inner door if either part rusts through due to defective materials or workmanship.	

**KITCHENAID, INC. DOES NOT ASSUME ANY RESPONSIBILITY FOR INCIDENTAL OR CONSEQUENTIAL DAMAGES.** Some states do not allow the exclusion or limitation of incidental or consequential damages, so this exclusion or limitation may not apply to you.

This warranty gives you specific legal rights and you may also have other rights which vary from state to state.

KitchenAid, Inc.  
St. Joseph, Michigan 49085, U.S.A.